

Article number: 12744000080110

Description: KLEE-coil 744 000 080.110
M8 Steel, zinc-pl. & chr. blue

Measures

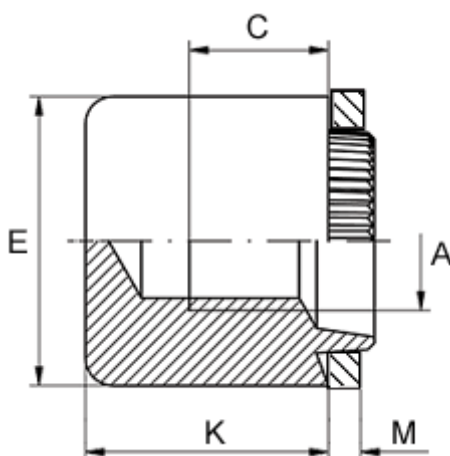

Female thread A	= M8
Height K	= 12.0
Min thread length C	= 6.0
Outer diameter E	= 16.0
Plate thickness	= 0.9 to 1.0
Recommended bore diameter for extreme load	= 13.0
Recommended bore diameter for normal use	= 13.0